

**2012 Baton Rouge Blastoff**

Saturday, 14Jan12

## Schedule for Pools A &amp; B

University High - Cts. 11 &amp; 12

Time	Teams	Ref
8A	1 v 3	2
9A	2 v 4	1
10A	1 v 4	3
11A	2 v 3	1
12N	3 v 4	2
1P	1 v 2	4

Matches may begin 15 minutes early if all involved teams agree.





Warm-ups: 2 minutes shared, followed by 4 minutes serving team, 4 minutes receiving team. (Serve within own 4 minutes.)





All matches are 2 out of 3 sets to 25 (deciding set to 15)

Missed referee assignment - 1 point p/minute beginning 5 minutes prior to scheduled match time. (Assesed on next set/match.) Coaches must second referee (R2).

After pool play 1st &amp; 2nd advance to championship bracket, 3rd &amp; 4th to consolation play

**There are no tie-break sets.** If 2 or more teams finish pool tied, teams will be seeded by;  
 1)sets won/loss pct., 2)point percentage [Pts scored divided by pts scored against. The higher point percentage is 1st seed from that pool, etc.] 3)Coin toss.

Pool A	University High - Ct.11				Match		Set		Fin
	LAVBC	CHAOS	STORM	CAJUN	W	L	W	L	
1 LAVBC 14 Elite Sivi		25-16 25-14	25-20 25-19	25-2 25-19	III		III I		1
2 Controlled Chaos State	16-25 14-25		16-25 25-18 8-15	26-24 25-12	I	II	III	IIII	3
3 Red Storm	20-25 19-25	25-16 18-25 15-8		25-17 25-17	II	I	IIII	III	2
4 Cajunland Kaki	2-25 19-25	24-26 25-12	17-25 17-25			III		III I	4

14's Pool B	University High - Ct.12				Match		Set		Fin
	CAJEL	CAJUN	LAVBC	ACERZ	W	L	W	L	
1 Cajun Elite Red		15-25 21-25	25-14 25-21	25-17 25-18	II	I	IIII	II	2
2 Cajunland Kenny	25-15 25-21		25-13 25-7	25-17 25-15	III		III I		1
3 LAVBC - VIA Molly	14-25 21-25	13-25 7-25		14-25 22-25		III		III I	4
4 Acerz	17-25 18-25	17-25 15-25	25-14 25-22		I	II	II	IIII	3

Schedule for Pools C & D  
Cts.9 & 10 - St. Joseph's

Time	Teams	Ref
230P	1 v 3	2
330P	2 v 4	1
430P	1 v 4	3
530P	2 v 3	1
630P	3 v 4	2
730P	1 v 2	4

Matches may begin 15 minutes early if all involved teams agree.





Warm-ups: 2 minutes shared, followed by 4 minutes serving team, 4 minutes receiving team.  
(Serve within own 4 minutes.)





All matches are 2 out of 3 sets to 25 (deciding set to 15)

Missed referee assignment - 1 point p/minute beginning 5 minutes prior to scheduled match time. (Assesed on next set/match.) Coaches must second referee (R2).

After pool play 1st & 2nd advance to championship bracket, 3rd & 4th to consolation play

**There are no tie-break sets.** If 2 or more teams finish pool tied, teams will be seeded by;  
1)sets won/loss pct., 2)point percentage [Pts scored divided by pts scored against. The higher point percentage is 1st seed from that pool, etc.] 3)Coin toss.

14's Pool C		St. Joseph's - Ct. 9				Match		Set		Fin
		BCRAB	CAJEL	CAJUN	LAVBC	w	L	w	L	
1	Blue Crab		18-25 24-26	25-15 25-11	25-21 25-15					2
2	Cajun Elite Black	25-18 26-24		25-16 25-13	25-18 25-23					1
3	Cajunland Rebecca	15-25 11-25	16-25 13-25		13-25 15-25					4
4	LAVBC - Spikers Michelle	21-25 15-25	18-25 23-25	25-13 25-15						3

14's Pool D		St. Joseph's - Ct.10				Match		Set		Fin
		ACADI	KREWE	CHAOS	LAVBC	w	L	w	L	
1	Acadian Jrs. Red National		21-25 13-25	25-21 25-23	25-21 25-13					2
2	Krewe of Cassidy	25-21 25-13		25-18 25-8	25-17 25-11					1
3	Controlled Chaos State - Beaumont	21-25 23-25	18-25 8-25		18-25 8-25					4
4	LAVBC - VIA Vanessa	21-25 13-25	17-25 11-25	25-18 25-8						3

Pool E 5-team schedule			
Cts.11 & 12 - University High			
Time	Teams		Ref
	Ct. 11	Ct.12	Both Courts
230P	1 v 4	2 v 5	3
330P	5 v 1	4 v 3	2
430P	2 v 3	4 v 5	1
530P	<i>Break</i>		
630P	1 v 3	2 v 4	5
730P	3 v 5	1 v 2	4

Matches may begin 15 minutes early if all involved teams agree.

Warm-ups: 2 minutes shared, followed by 4 minutes serving team, 4 minutes receiving team. (Serve within own 4 minutes.)





All matches are 2 out of 3 sets to 25 (deciding set to 15)

Missed referee assignment - 1 point p/minute beginning 5 minutes prior to scheduled match time. (Assesed on next set/match.) Coaches must second referee (R2).

After pool play 1st & 2nd advance to championship bracket, 3rd, 4th, 5th to consolation play

**There are no tie-break sets.** If 2 or more teams finish pool tied, teams will be seeded by;

1)sets won/loss pct., 2)point percentage [Pts scored divided by pts scored against. The higher point percentage is 1st seed from that pool, etc.] 3)Coin toss.

14's Pool E		University High - Cts. 11 & 12					Match		Set		Fin
		CAJUN	ACADI	LAVBC	NORTH	CAJEL	W	L	W	L	
1	Cajunland Greg		25-21 25-14	25-9 9-25 15-5	25-21 25-14	25-16 25-17					1
2	Acadian Jrs. Navy Nat'l	21-25 14-25		3-25 24-26	16-25 17-25	28-26 25-20					4
3	LAVBC VIA Eric	9-25 25-9 5-15	25-3 26-24		11-25 25-18 7-15	25-13 25-14					3
4	Northshore	21-25 14-25	25-16 25-17	25-11 18-25 15-7		25-16 25-18					2
5	Cajun Elite White	16-25 17-25	26-28 20-25	13-25 14-25	16-25 18-25						5

# 14 Gold Bracket

Sunday, 15Jan12

LSU Recreation Center - Cts. 7 & 8

## Acadian Jrs. Red Nat'l

11A - Ct. 7  
Ref - Prv Isr

## Krewe of Cassidy

## Cajun Elite Red

8A - Ct. 7  
Ref - 1st E

## Acadian Jrs. Red Nat'l

## Cajun Elite Red

25-23, 15-25, 15-11

## LAVBC 14 Elite Sivi

10A - Ct. 7  
Ref - Prv Isr

## Cajunland Greg

9A - Ct. 7  
Ref - Prv Isr

## Krewe of Cassidy

## Cajun Elite Black

9A - Ct. 8  
Ref - Prv Isr

## Northshore

## Blue Crab

25-9, 25-14

10A - Ct. 8  
Ref - Prv Isr

## Cajunland Kenny

## LAVBC 14 Elite Sivi

25-14, 28-26

12N - Ct. 7  
Ref - Prv Isr

18-25, 25-23, 15-11

## Cajunland Greg

## LAVBC 14 Elite Sivi

25-15, 25-18

1P - Ct. 7  
Ref - Prv Isr

## LAVBC Elite Sivi

25-18, 19-25, 15-7

## Cajun Elite Black

25-22, 25-19

12N - Ct. 8  
Ref - Prv Isr

25-23, 25-23

## Blue Crab

25-13, 25-23

## Blue Crab

## Cajun Elite Red

Lsr 10A-Ct.7 match

1P - Ct. 8  
Ref - Prv Isr

Lsr 10A-Ct.8 match

## Cajunland Kenny

## Cajunland Kenny

29-27, 25-11

>>> Referee previous match on this court.\*

14 Consolation Brackets  
 Sunday, 15Jan12  
 Cts. 9 & 10 - St. Joseph's

**Consolation Bracket A**  
 Court 9

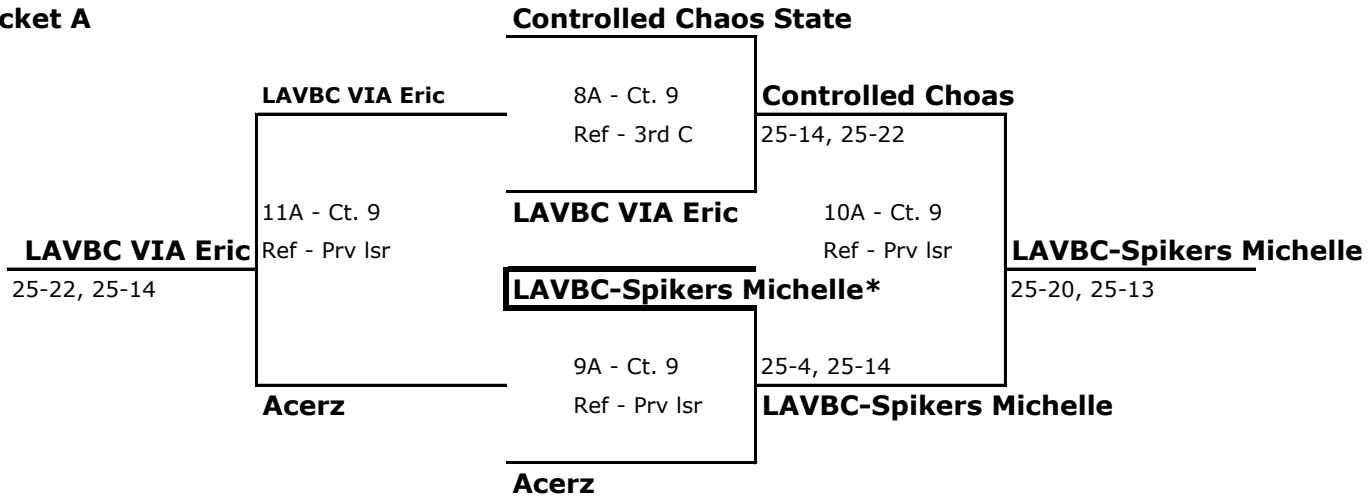

>>> Referee previous match on this court.\*

**Consolation Bracket B**  
 Court 10

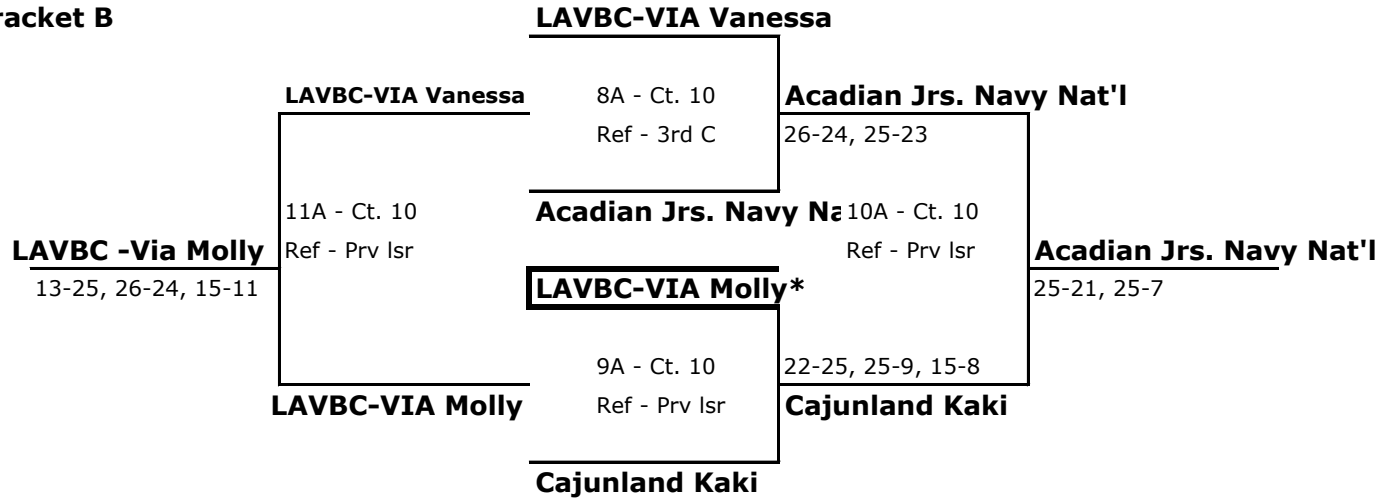

>>> Referee previous match on this court.\*

# 14 Consolation Pool

Sunday, 15Jan12

LSU Recreation Center - Ct. 8



14 Consolation schedule LSU - Ct. 8		
Time	Teams	Ref
2P	1 v 3	2
3P	2 v 3	1
4P	1 v 2	3

Matches may begin 15 minutes early if all involved teams agree.

Warm-ups: 2 minutes shared, followed by 4 minutes serving team, 4 minutes receiving team.  
(Serve within own 4 minutes.)

All matches are 2 out of 3 sets to 25 (deciding set to 15)

Missed referee assignment - 1 point p/minute beginning 5 minutes prior to scheduled match time. (Assesed on next set/match.) Coaches must second referee (R2).

14 Consolation Pool		LSU - Ct.8			Matches		Sets		Place
		CAJUN	CHAOS	CAJEL	W	L	W	L	
1	Cajunland Rebecca		25-20 25-18	25-23 21-25 8-15	I	I	III	II	2
2	Controlled Chaos State - Beaumont	20-25 18-25		25-17 19-25 13-15		II	I	IIII	3
3	Cajun Elite White	23-25 25-21 15-8	17-25 25-19 15-13		II		IIII	II	1