

2012 Baton Rouge Blastoff

Saturday, 14Jan12

Schedule for 15 pool play
Zachary HS / Cts. 1, 2, 3

Warm-ups: 2 minutes shared, followed by 4 minutes serving team, 4 minutes receiving team. (Serve within own 4 minutes.) Matches may begin 15 minutes early if all involved teams agree.

Time	Teams	Ref
8A	1 v 3	2
9A	2 v 4	1
10A	1 v 4	3
11A	2 v 3	1
12N	3 v 4	2
1P	1 v 2	4



Coaches must second referee (R2).



Missed referee assignment - 1 point p/minute beginning 5 minutes prior to scheduled match time. (Assesed on next set/match.)





After Pools A, B & C play, top two teams in each pool advance to Championship Bracket, 3rd & 4th place to Consolation Pools.

Pools D & E will play cross challenge matches after pool play to determine position for Sunday.

There are no tie-break sets. If 2 or more teams finish pool tied, teams will be seeded by; 1)sets won/loss pct., 2)point percentage [Pts scored divided by pts scored against. The higher point percentage is 1st seed from that pool, etc.] 3)Coin toss.

Pool A		Zachary H.S. / Ct. 1				Matches		Sets		Place
		CCITY	CAJUN	LAVBC VIA	CWAVE	W	L	W	L	
1	Crescent City Jrs.		25-13 25-6	25-22 25-21	25-10 25-9	III		III I		1
2	Cajunland Sara		13-25 6-25		20-25 17-25	I	II	II	III	3
3	LAVBC - VIA Jody		22-25 21-25	25-20 25-17		II	I	IIII	II	2
4	Cajun Wave		10-25 9-25	25-12 24-26 10-15	17-25 13-25		III	I	III I	4

Pool B		Zachary H.S. / Ct. 2				Matches		Sets		Place
		LAVBC LAVB	CHAOS	CAJEL	LAVBC VIA	W	L	W	L	
1	LAVBC - LAVB 15 Elite Becky		25-12 21-25 15-7	25-16 19-25 15-13	25-11 25-11	III		III I	II	1
2	Controlled Chaos 15 National		12-25 25-21 7-15		22-25 21-25	I	II	III	IIII	3
3	Cajun Elite		16-25 25-19 13-15	25-22 25-21		II	I	III	II	2
4	LAVBC - VIA Henry		11-25 11-25	10-25 9-25	21-25 19-25		III		III I	4

Pool C		Zachary H.S. / Ct. 3				Matches		Sets		Place
		BCRAB	STORM	LAVBC LVBR	ACERZ	W	L	W	L	
1	Blue Crab		25-22 25-21	25-11 25-16	25-15 25-10	III		III I		1
2	Red Storm	22-25 21-25		25-21 25-19	25-13 25-8	II	I	III	II	2
3	LAVBC - LVBR 15 Venessa	11-25 16-25	21-25 19-25		25-15 25-18	I	II	II	III	3
4	Acers	15-25 10-25	13-25 8-25	15-25 18-25			III		III I	4

15's 3-team schedule		
Northwest Middle - Ct.s 4 & 5		
Time	Teams	Ref
8A	1 v 3	2
9A	2 v 3	1
10A	1 v 2	3



Matches may begin 15 minutes early if all involved teams agree.



Warm-ups: 2 minutes shared, followed by 4 minutes serving team, 4 minutes receiving team. (Serve within own 4 minutes.)

All matches are 2 out of 3 sets to 25 (deciding set to 15)

After pool play, teams from Pools D & E will play challenge matches to determine position for Sunday competition.

There are no tie-break sets. If 2 or more teams finish pool tied, teams will be seeded by; 1)sets won/loss pct., 2)point percentage [Pts scored divided by pts scored against. The higher point percentage is 1st seed from that pool, etc.] 3)Coin toss.

Pool D		Northwest Middle School / Ct. 4			Matches		Sets		Place
		KREWE	CHAOS	CAJUN	W	L	W	L	
1	Krewe of Denise		25-20 25-17	25-7 25-11	II		III		1
2	Controlled Chaos 15.2 State	20-25 17-25		22-25 25-16 12-15		II	I	III	3
3	Cajunland Gina	7-25 11-25	25-22 16-25 15-12		I	I	II	III	2

Pool E		Northwest Middle School / Ct. 5			Matches		Sets		Place
		Chaos	Acadi	LAVBC	W	L	W	L	
1	Controlled Chaos 15 State		20-25 14-25	10-25 25-19 9-15		II	I	III	3
2	Acadian Jrs. Red National	25-20 25-14		25-10 25-10	II		III		1
3	LAVBC - Spikers 15 Beau	25-10 19-25 15-9	10-25 10-25		I	I	II	III	2

Pools D & E Challenge Matches

Chal M#1

Controlled Chaos 15.2 State

Ct.4 - 11A
Ref - 2nd D

Controlled Chaos 15 State
25-14, 25-22

Controlled Chaos 15 state

Chal M#2

Acadian Jrs. Red

Ct.4 - 12N
Ref - Prv Isr

Acadian Jrs. Red
25-13, 25-5

Cajunland Gina

Chal M#3

Krewe of Denise

Ct.4 - 1P
Ref - Prv Isr

Krewe of Denise

LABVC Spickers Beau

* Ref previous match on this court



15 Consolation Pools

Sunday, 15Jan12

15 Consolation A Schedule		
LSU - Ct. 7		
Time	Teams	Ref
2P	1 v 3	2
3P	2 v 3	1
4P	1 v 2	3



15 Consolation B Schedule		
University High - Ct. 12		
Time	Teams	Ref
8A	1 v 3	2
9A	2 v 3	1
10A	1 v 2	3

Matches may begin 15 minutes early if all involved teams agree.

Warm-ups: 2 minutes shared, followed by 4 minutes serving team, 4 minutes receiving team. (Serve within own 4 minutes.)

All matches are 2 out of 3 sets to 25 (deciding set to 15)

Missed referee assignment - 1 point p/minute beginning 5 minutes prior to scheduled match time. (Assesed on next set/match.)

Consolation Pool A	LSU - Ct. 7			Match		Set		Fin
	Spikers	CAJUN	LAVBC	W	L	W	L	
1 LABVC Spikers Beau		25-23 25-19	22-25 25-8 15-12					1
2 Cajunland Sara	23-25 19-25		24-26 25-19 15-8					2
3 LAVBC LVBR 15 Venessa	25-22 8-25 12-15	26-24 19-25 8-15						3

Consolation Pool B	University High - Ct. 12			Match		Set		Fin
	CAJUN	CHAOS Natl	CHAOS State	W	L	W	L	
1 Cajunland Gina		14-25 16-25	6-25 8-25					3
2 Controlled Chaos 15 National	25-14 25-16		15-25 19-25					2
3 Controlled Chaos 15 State	25-6 25-8	25-15 25-19						1

15 Consolation Bracket

Sunday, 15Jan12
LSU - Ct.6

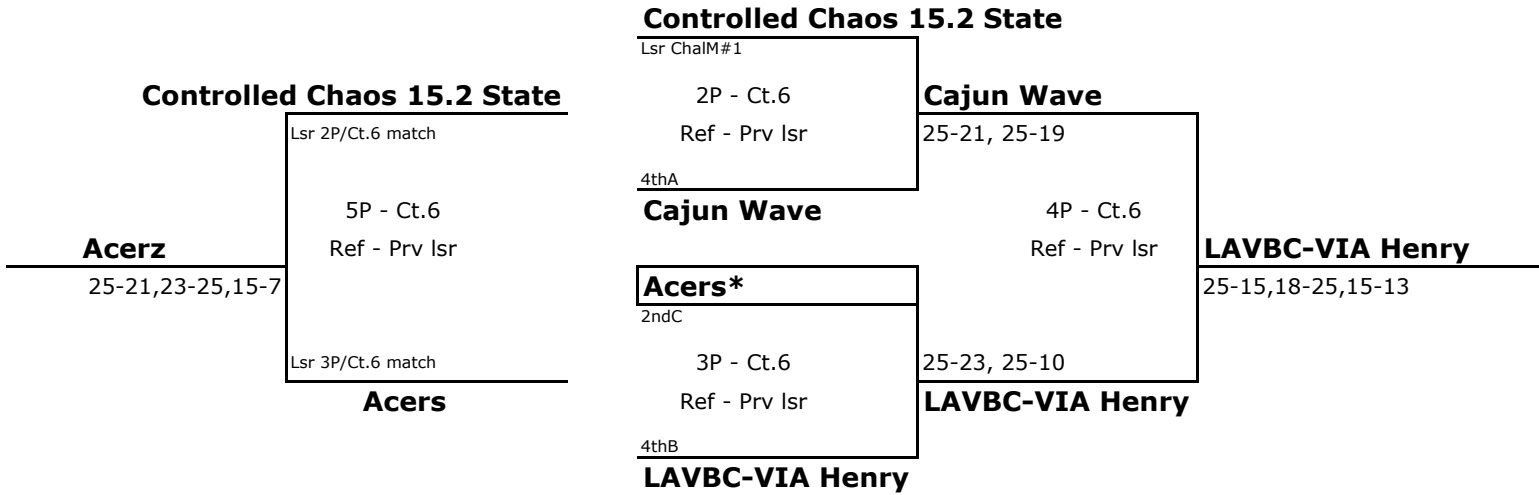

>>> Referee previous match on this court.*



15 Gold Bracket

Sunday, 15Jan12

Northwest Middle - Cts. 4 & 5

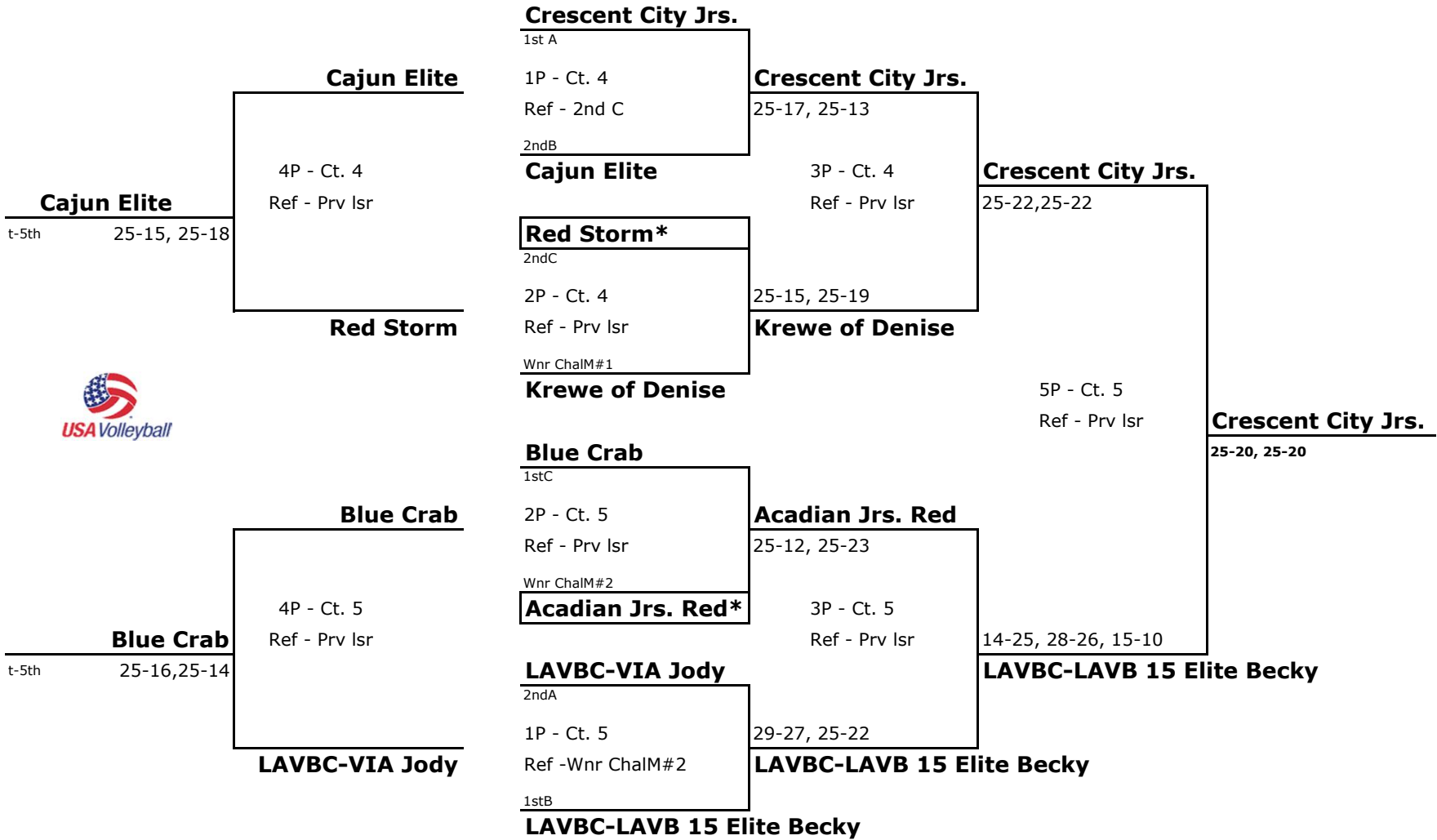

>>> Referee previous match on this court.*